



WHO Collaborating Centre
for Injury Prevention
and Safety Promotion



โรงพยาบาลขอนแก่น
KHON KAEN HOSPITAL



TNC Role in Emergency Department



Thanyaras Piyawatchwela
*Registered nurse, Senior Professional Level
Supervisor nurse of Emergency department
Khon Kaen Hospital*



WHO Collaborating Centre
for Injury Prevention
and Safety Promotion



โรงพยาบาลขอนแก่น
KHON KAEN HOSPITAL



Outline

- Structure / Staff ER nurse
- Role of Trauma nurse coordinator at ER
- ER nurse competency

International Online Training

“ Capacity Building on Trauma Administrative Management for
Trauma Medical Directors and Trauma Nurse Coordinators in Southeast Asia Region ”



Number of ED visits 2013-2021

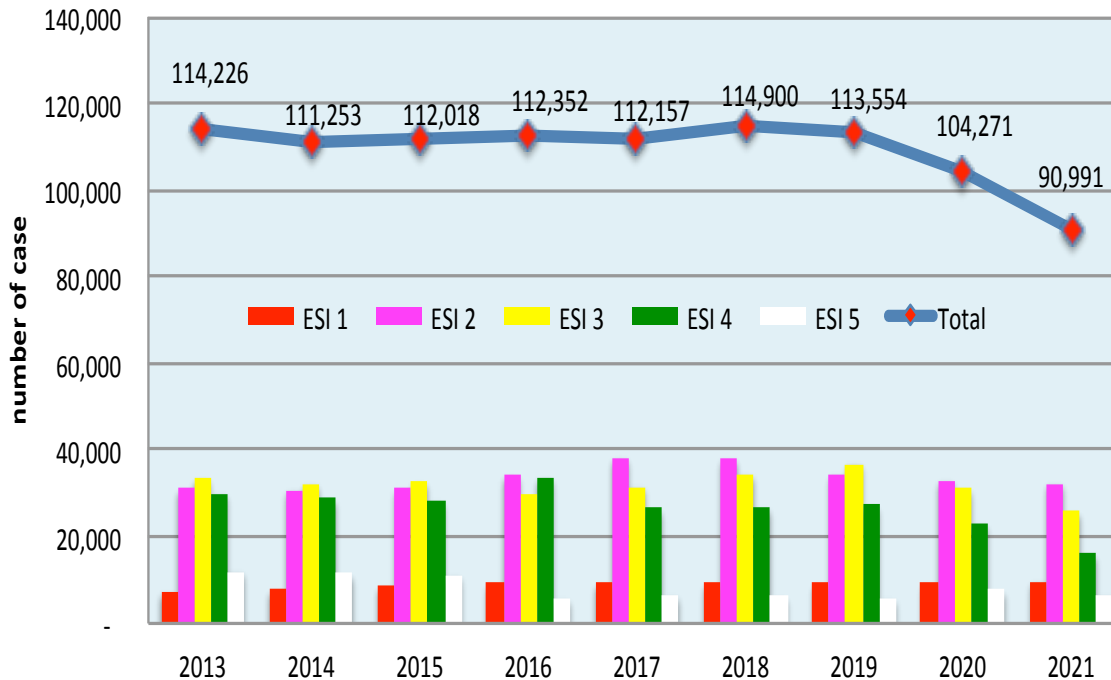

ED visits in 2021

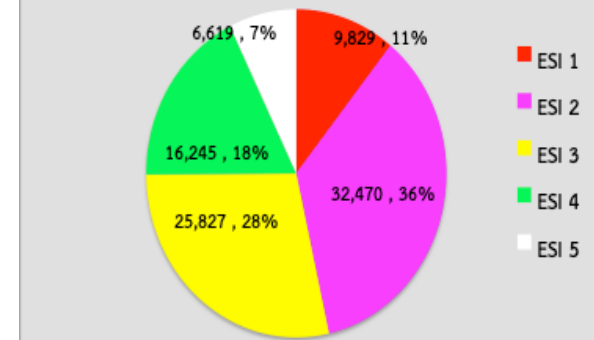

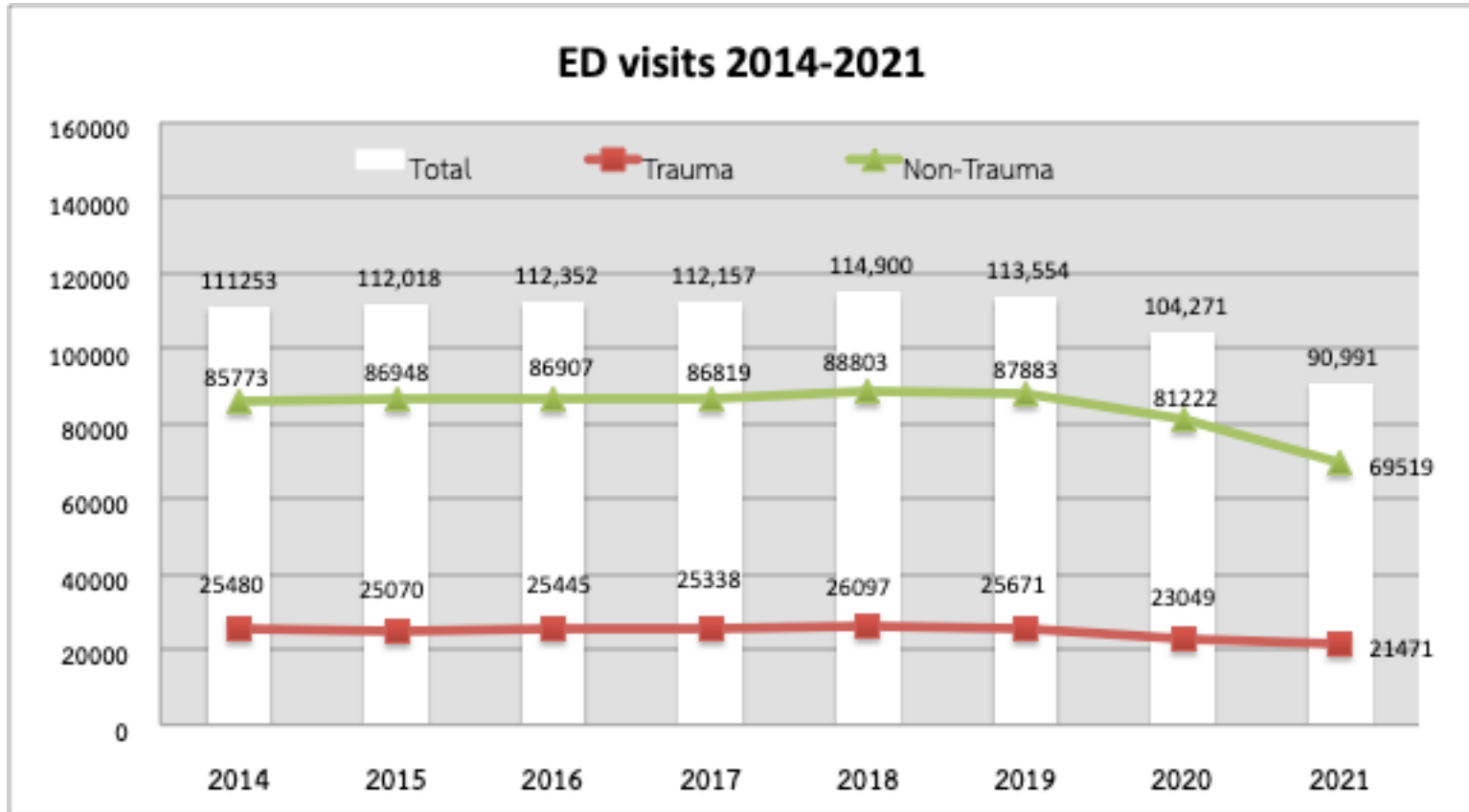



Structure Emergency Nursing Unit , Khonkaen Hospital

1. TEA Unit
2. Emergency Room
3. Referral Center

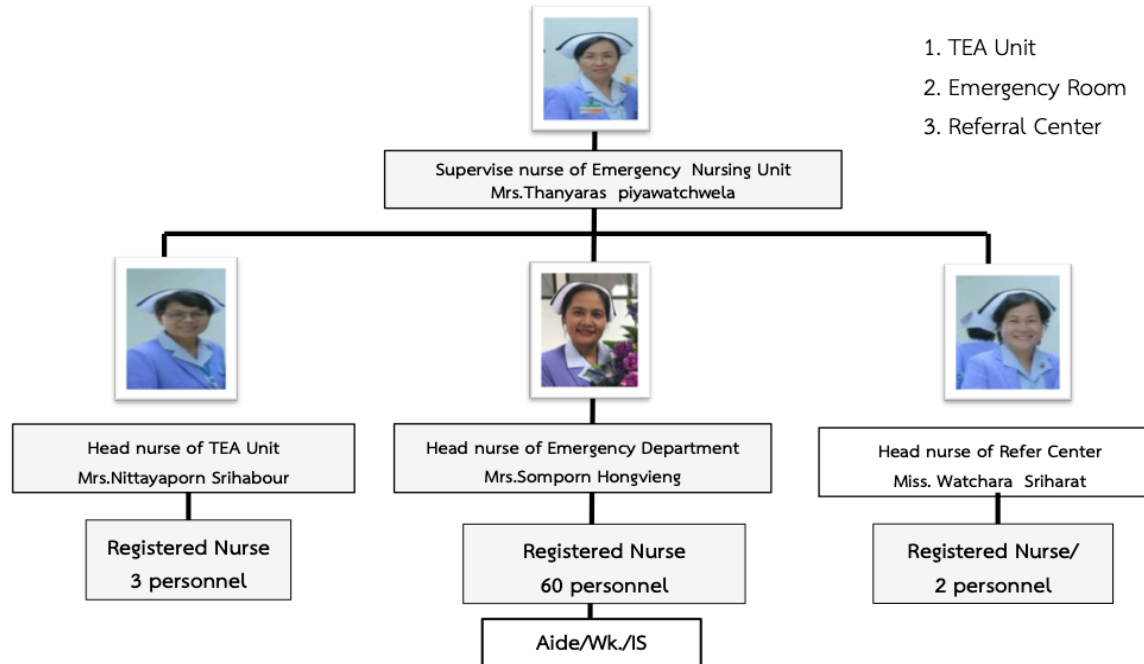



WHO Collaborating Centre
for Injury Prevention
and Safety Promotion



โรงพยาบาลขอนแก่น
KHON KAEN HOSPITAL



Nurses in Emergency Department

Registered nurse 60

- Bachelor degree 31(51.67)
- Master degree 8 (13.3%)
- ENP/EN 13 (21.7%)
- Critical care 1 (1.7 %)
- TNM 3 (5.0 %)
- Nursing Administrative 4 (6.7 %)



International Online Training

“ Capacity Building on Trauma Administrative Management for
Trauma Medical Directors and Trauma Nurse Coordinators in Southeast Asia Region ”



ED Nurse Competency level

Competency level	Total
Novice (0-2 yrs)	13
Adv. Beginner (3-4yrs)	3
Competent(5-7yrs)	5
Proficient(8-10)	11
Expert (>10yrs)	28
Total	60

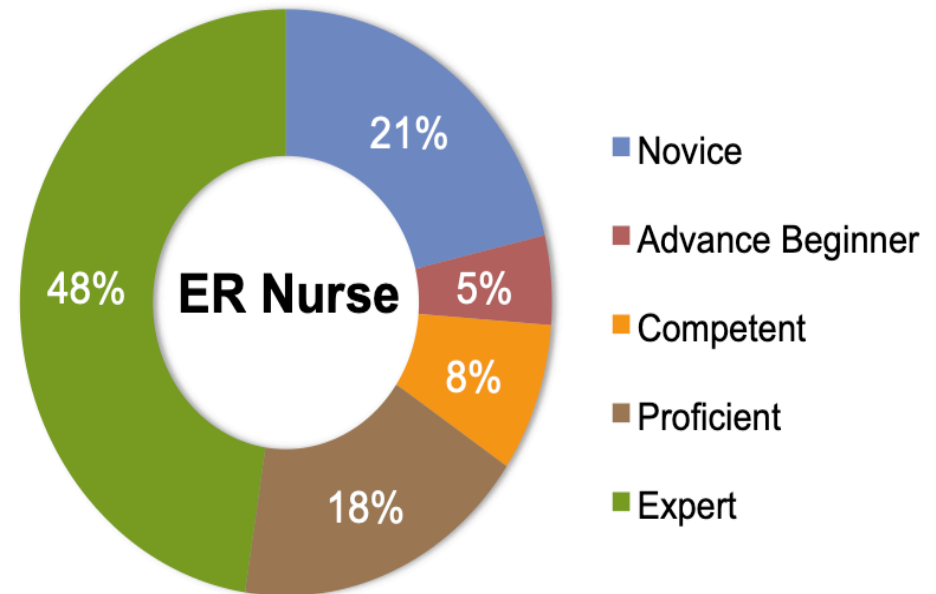



Manpower



Shift =8 hrs	Sup/Head/ Staff nurse	Register nurse	total
8 am-4 pm	4	23	27
4 pm-12 am	-	20	21
12 am-8 am	-	12	12

International Online Training

“ Capacity Building on Trauma Administrative Management for
Trauma Medical Directors and Trauma Nurse Coordinators in Southeast Asia Region ”



ED visits in KhonKaen Hospital 2014-2021

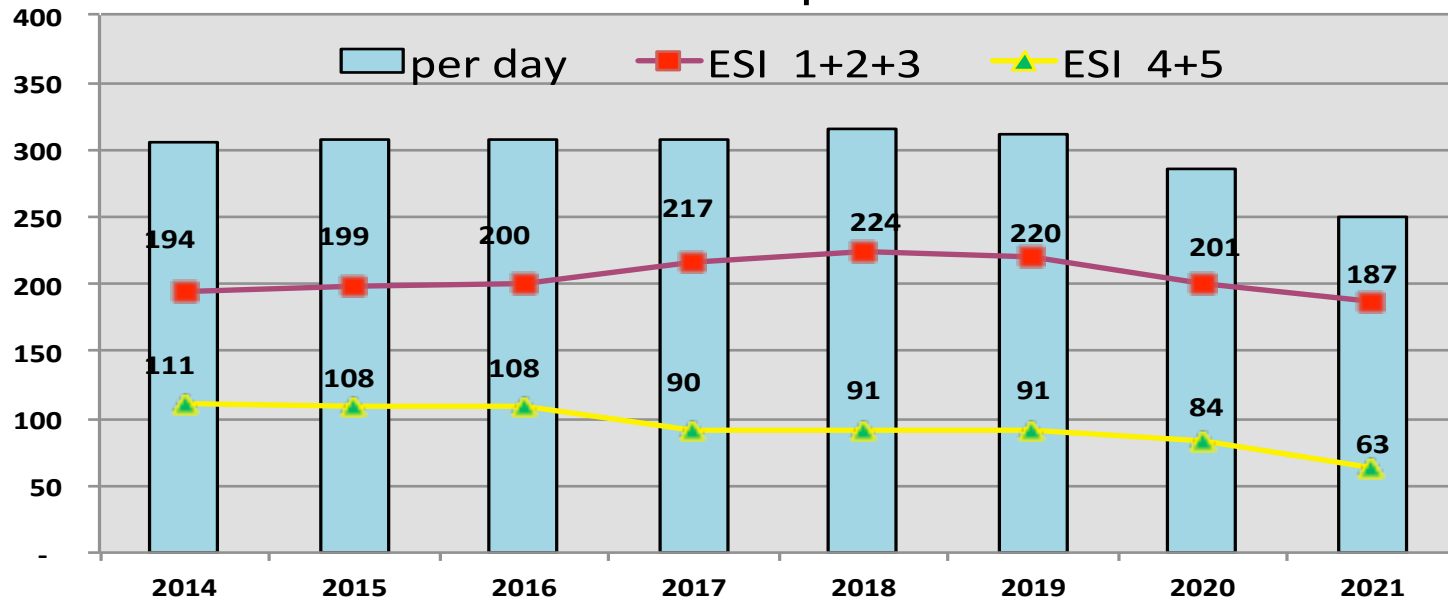

International Online Training

“ Capacity Building on Trauma Administrative Management for
Trauma Medical Directors and Trauma Nurse Coordinators in Southeast Asia Region ”



Assignment	Shift (8 hrs)		
	Day	Evening	Night
Incharge	1	1	1
ER call center	2	1	0
Triage	3	3	1
Consultation Zone	2	1	0
Clean ZONE	5	5	3
Isolation ZONE	5	4	3
Resuscitation Zone	4	4	3
ER nurse manager	1	1	1
Total	23+4*	20	12

* Supervisor /head nurse /senior staff nurse



ER Patient Flow

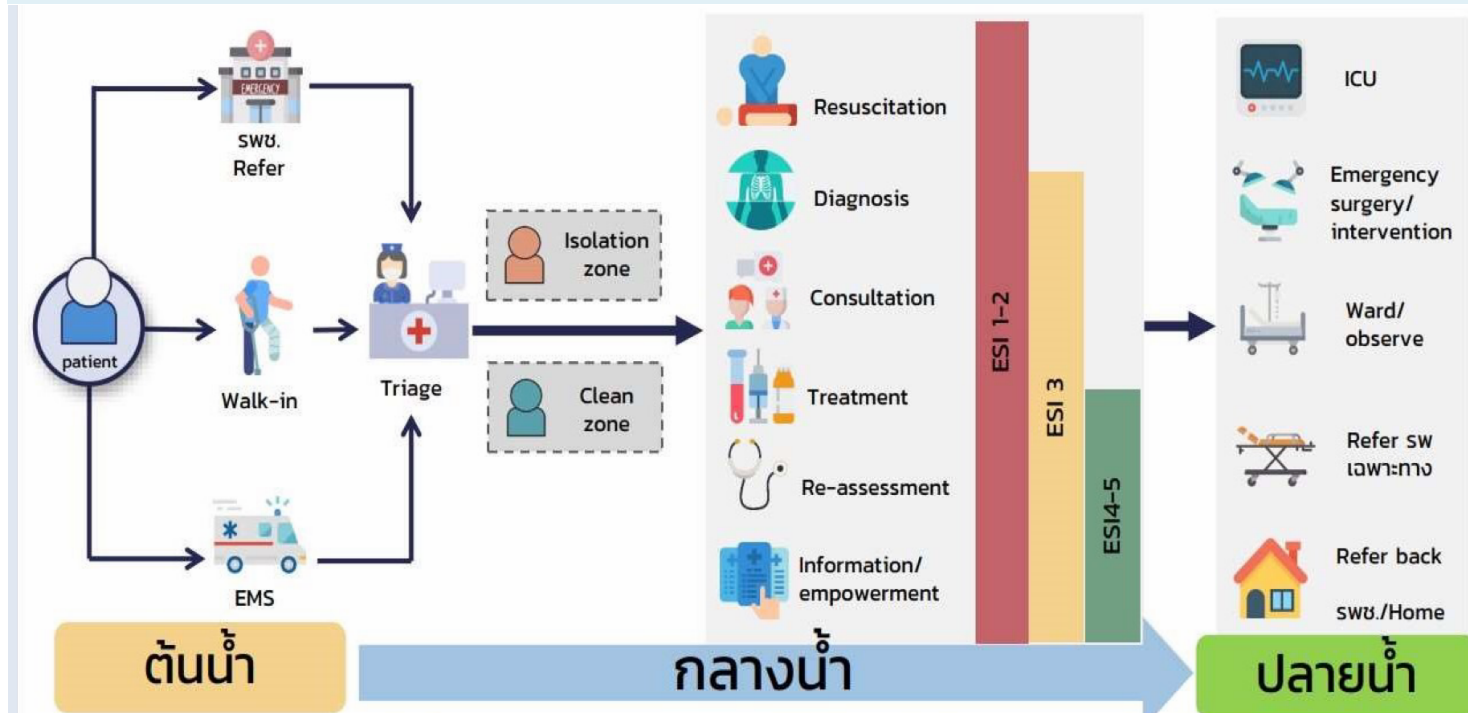

(Department of Medical Services ,MOPH)



FAST TRACT

8

Trauma Fast tract

- Multiple injury (Trauma Fast tract)
- Head injury
- C-Spine

Non Trauma Fast tract

- STEMI
- Stroke
- Severe Sepsis & Septic shock
- Pediatric
- High risk Pregnancy

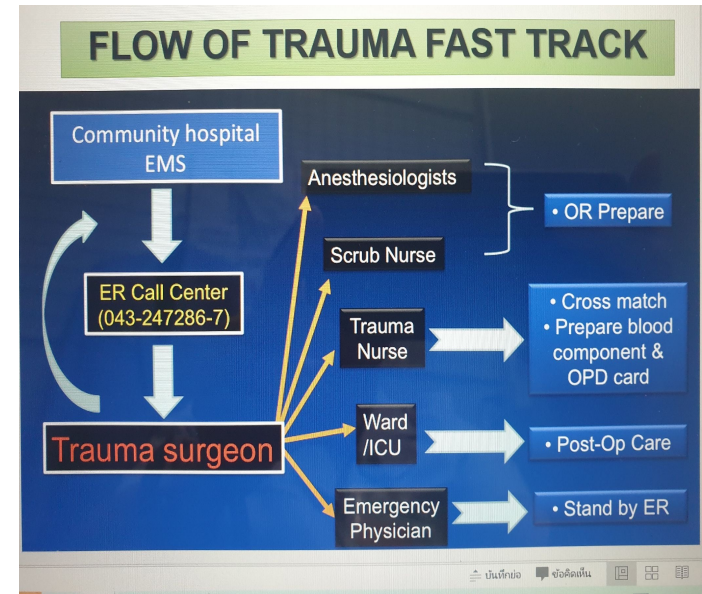

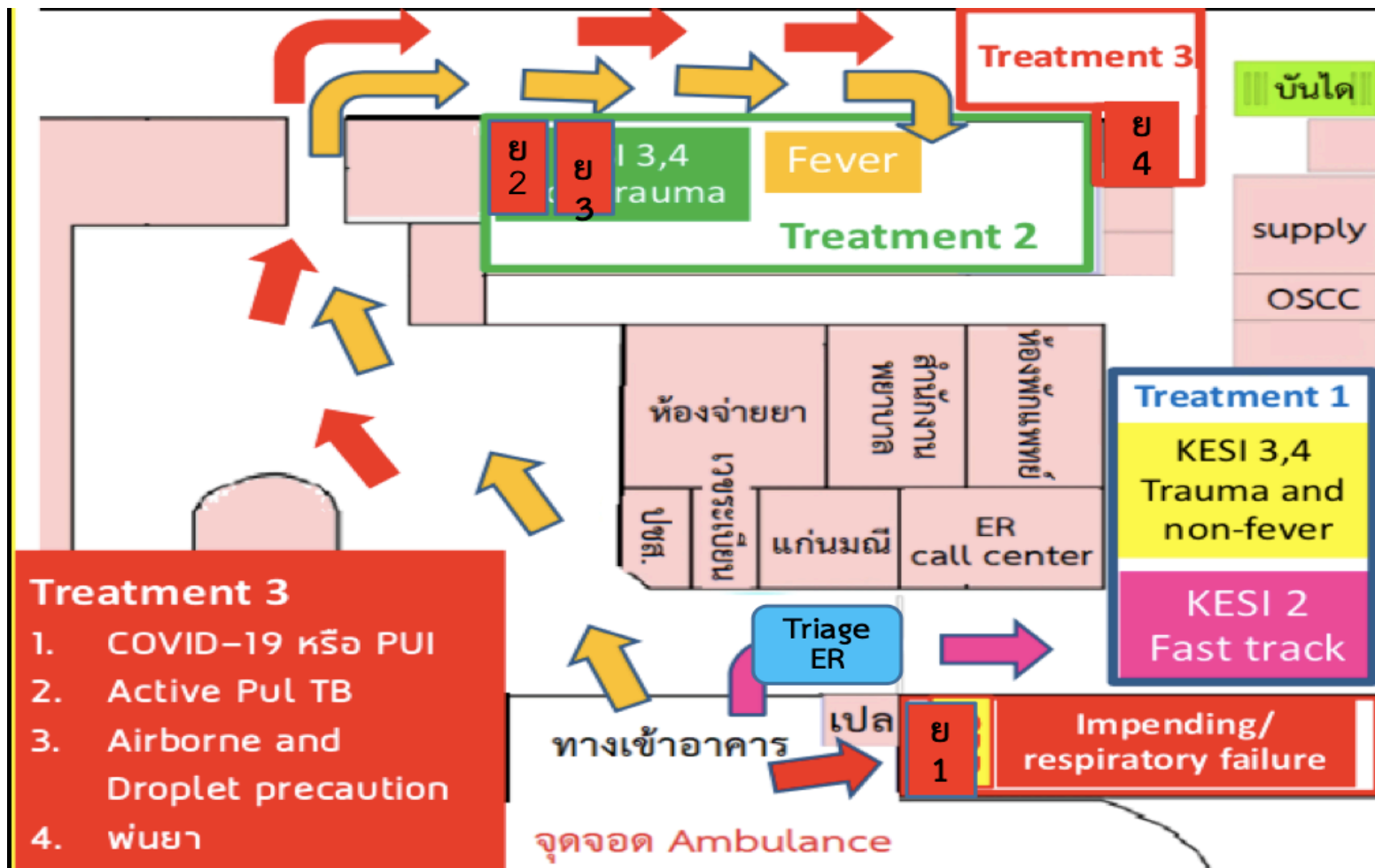



WHO Collaborating Centre
for Injury Prevention
and Safety Promotion



โรงพยาบาลขอนแก่น
KHON KAEN HOSPITAL



zone ตามโครงสร้างและระบบปรับ
อากาศและระบบระบายอากาศ



Resuscitation เป็น semi-
negative เป็น buffer zone สำหรับ
ET tube, intubate, CPR



Negative 1 ห้อง สำหรับ PUI หรือ
suspected COVID หรือ active TB
และอื่นๆ ที่เป็น droplet/airborne



zone ตามโครงสร้างและระบบปรับ
อากาศและระบบระบายอากาศ

treatment 1

FAST TRACT, trauma
และ non-trauma(non-
fever)



Treatment2

buffer zone (มีหน้าต่าง
ระบายอากาศ) สำหรับ
fever รวม fast tract
with fever), observe





WHO Collaborating Centre
for Injury Prevention
and Safety Promotion



โรงพยาบาลขอนแก่น
KHON KAEN HOSPITAL



Treatment 3 (Contagion zone) **New Zone**



ER KKH in COVID-19 pandemic



WHO Collaborating Centre
for Injury Prevention
and Safety Promotion



โรงพยาบาลขอนแก่น
KHON KAEN HOSPITAL



KESI : KhonKaen Emergency Severity Index

ให้บริการผู้ป่วยตามความเร่งด่วนดังนี้

สีแดง	ผู้ป่วยวิกฤต	ตรวจทันที
สีชมพู	เจ็บป่วยรุนแรง	รอตรวจ 5-15 นาที
สีเหลือง	เจ็บป่วยปานกลาง	รอตรวจ 15-30 นาที
สีเขียว	เจ็บป่วยเล็กน้อย	รอตรวจ 30-60 นาที
สีขาว	ผู้ป่วยทั่วไป	รอตรวจ 1-2 ชั่วโมง

KESI 1

Resuscitation

KESI 2

Emergent

KESI 3

Urgent

KESI 4

Less-urgent

KESI 5

Non-urgent

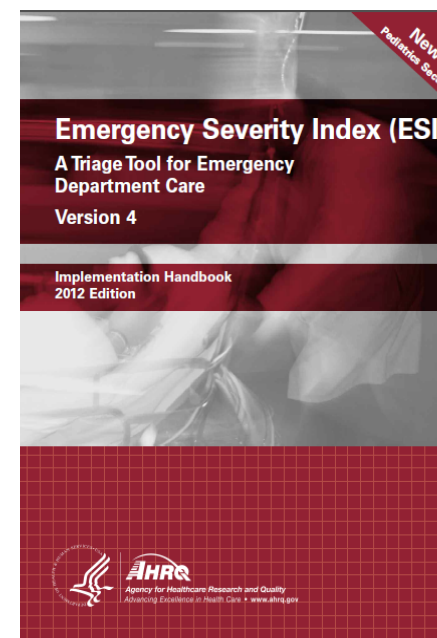

International Online Training

“ Capacity Building on Trauma Administrative Management for
Trauma Medical Directors and Trauma Nurse Coordinators in Southeast Asia Region ”



KESI Conceptual Algorithm

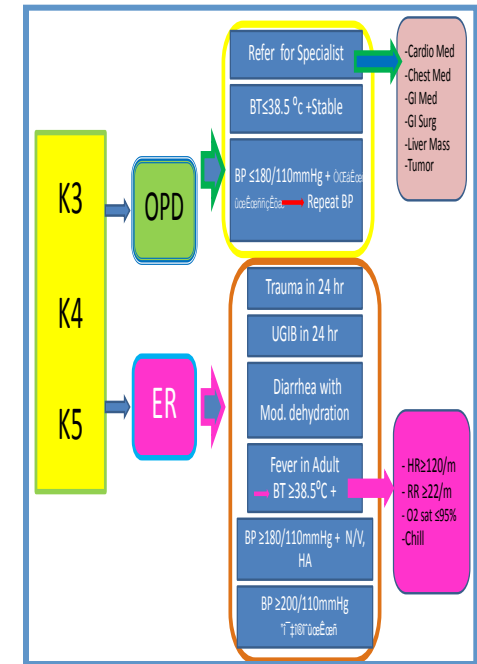
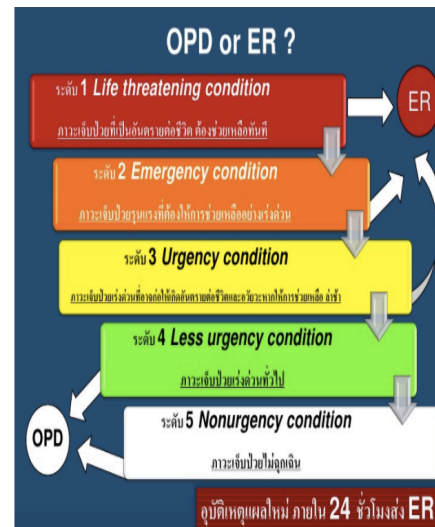
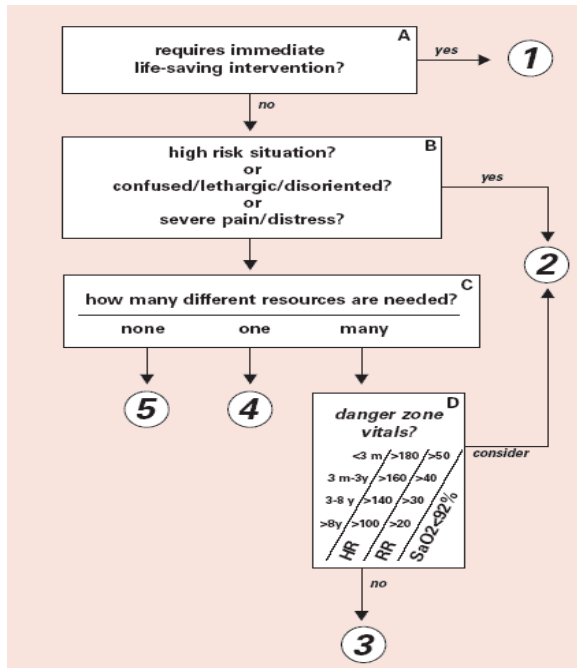
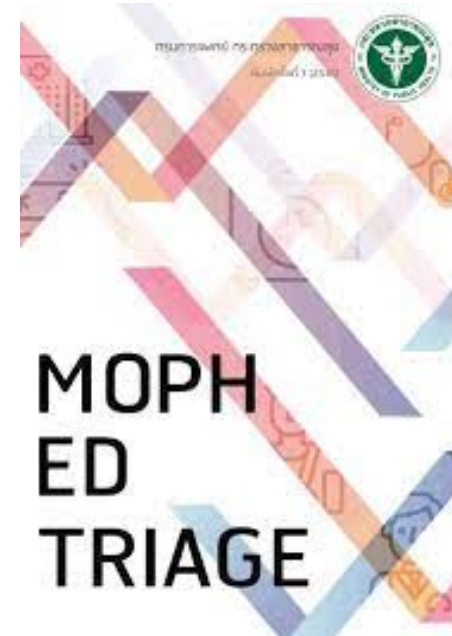



Table 3-3. ESI Resources

Resources	Not resources
Labs (blood, urine)	History & physical (including pelvic)
ECG, X-rays CT-MRI-ultrasound angiography	Point-of-care testing
IV fluids (hydration)	Saline or heplock
IV, IM or nebulized medications	PO medications Tetanus immunization Prescription refills
Specialty consultation	Phone call to PCP
Simple procedure = 1 (lac repair, Foley cath)	Simple wound care (dressings, recheck)
Complex procedure = 2 (conscious sedation)	Crutches, splints, slings





ER Nurse Training

- Pre-Hospital Emergency Nurse : PHEN (5 days)
- Referral Nurse (3 days)
- Emergency Nurse Practitioner : ENP(4month)
- PALS, ACLS ,Disaster
- Hospital Preparedness for Emergency :HoPE
- Advance Trauma Care for Nurse
- Assertive in Workplace





ER Nurse Competency

- ED triage
- Emergency condition : Trauma , Stroke, STEMI, Pregnancy Pediatric, ACLS, BLS
- Communication skill: Woman Violence
- Interpretation skill: EKG
- Pharmacology : High alert drug, Drug interaction
- Patient management : PEP,Fast Track
- Special Equipment
- Risk management





WHO Collaborating Centre
for Injury Prevention
and Safety Promotion



โรงพยาบาลขอนแก่น
KHON KAEN HOSPITAL



ER Nurse competency



OSCEs (Objective Structured Clinical Examinations)

: Stations are designed to test knowledge and understanding of assessment ,planning implementation and evaluation of nursing care

**International Online Training
“ Capacity Building on Trauma Administrative Management for
Trauma Medical Directors and Trauma Nurse Coordinators in Southeast Asia Region ”**



WHO Collaborating Centre
for Injury Prevention
and Safety Promotion



โรงพยาบาลขอนแก่น
KHON KAEN HOSPITAL



International Online Training
“ Capacity Building on Trauma Administrative Management for
Trauma Medical Directors and Trauma Nurse Coordinators in Southeast Asia Region ”



WHO Collaborating Centre
for Injury Prevention
and Safety Promotion



โรงพยาบาลขอนแก่น
KHON KAEN HOSPITAL



Equipment

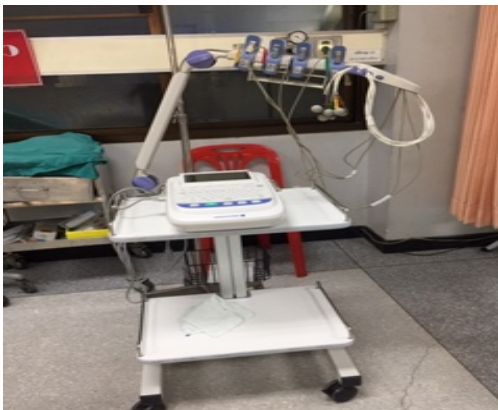

International Online Training
“ Capacity Building on Trauma Administrative Management for
Trauma Medical Directors and Trauma Nurse Coordinators in Southeast Asia Region ”



WHO Collaborating Centre
for Injury Prevention
and Safety Promotion



โรงพยาบาลขอนแก่น
KHON KAEN HOSPITAL



Scenario in situation



International Online Training
“ Capacity Building on Trauma Administrative Management for
Trauma Medical Directors and Trauma Nurse Coordinators in Southeast Asia Region ”



WHO Collaborating Centre
for Injury Prevention
and Safety Promotion



โรงพยาบาลขอนแก่น
KHON KAEN HOSPITAL



Hospital Crisis Management Exercise : HoCMEX)



International Online Training
“ Capacity Building on Trauma Administrative Management for
Trauma Medical Directors and Trauma Nurse Coordinators in Southeast Asia Region ”



Trauma Nurse Coordinator Role

Trauma Audit

- ผู้ป่วยทุกรายที่เสียชีวิตด้วยอุบัติเหตุ
Ps > 0.75
- โดยที่สหสาขาวิชาชีพทุกเดือน



No.	Adverse event/Errors	Policies/Guideline /Action Plan
1	Delayed CT Film	Guideline CT scan , Multi-Disciplinary conference
2	Delayed surgery	Trauma Fast Track
3	Miss diagnosis	X-rays Conference / TM noon report
4	Communication / System problems	Interdisciplinary conference / Interdepartmental conference (Ortho / EP)
5	Delayed blood transfusion	Multi-disciplinary team conference
6	Transfer problem (ward to ICU)	APACHE II
7	Transfer problem (local hospital)	TEC , APACHE II , TFT
8	Complication of procedure	Training , Journal club , KM

Triage Audit in 2018

KESI	Correct (%)	Overtriage (%)	Undertriage (%)
1	82	18	0
2	74.4	23.2	2.3
3	80	14.3	5.7
4	56.6	16.7	26.6
5	85.7	0	14.3

CPR Audit

- บทบาทพระภิกษณ์ผู้ป่วย cardiac arrest ทุกทราจ
- Scenario in situ เดือนวันเดือน
- ประเมินขณะปฏิบัติจริง

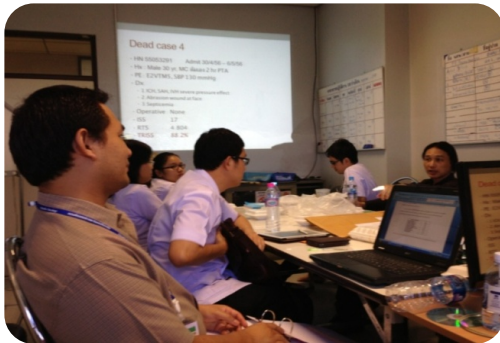
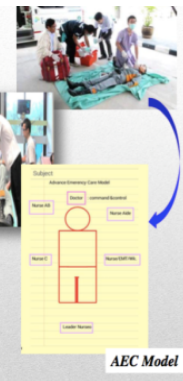
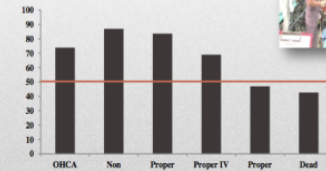

Dead case conference



PST Conference



Multidisciplinary conference

International Online Training

“ Capacity Building on Trauma Administrative Management for Trauma Medical Directors and Trauma Nurse Coordinators in Southeast Asia Region ”



Percentage of ROSC at ER 2019-2022

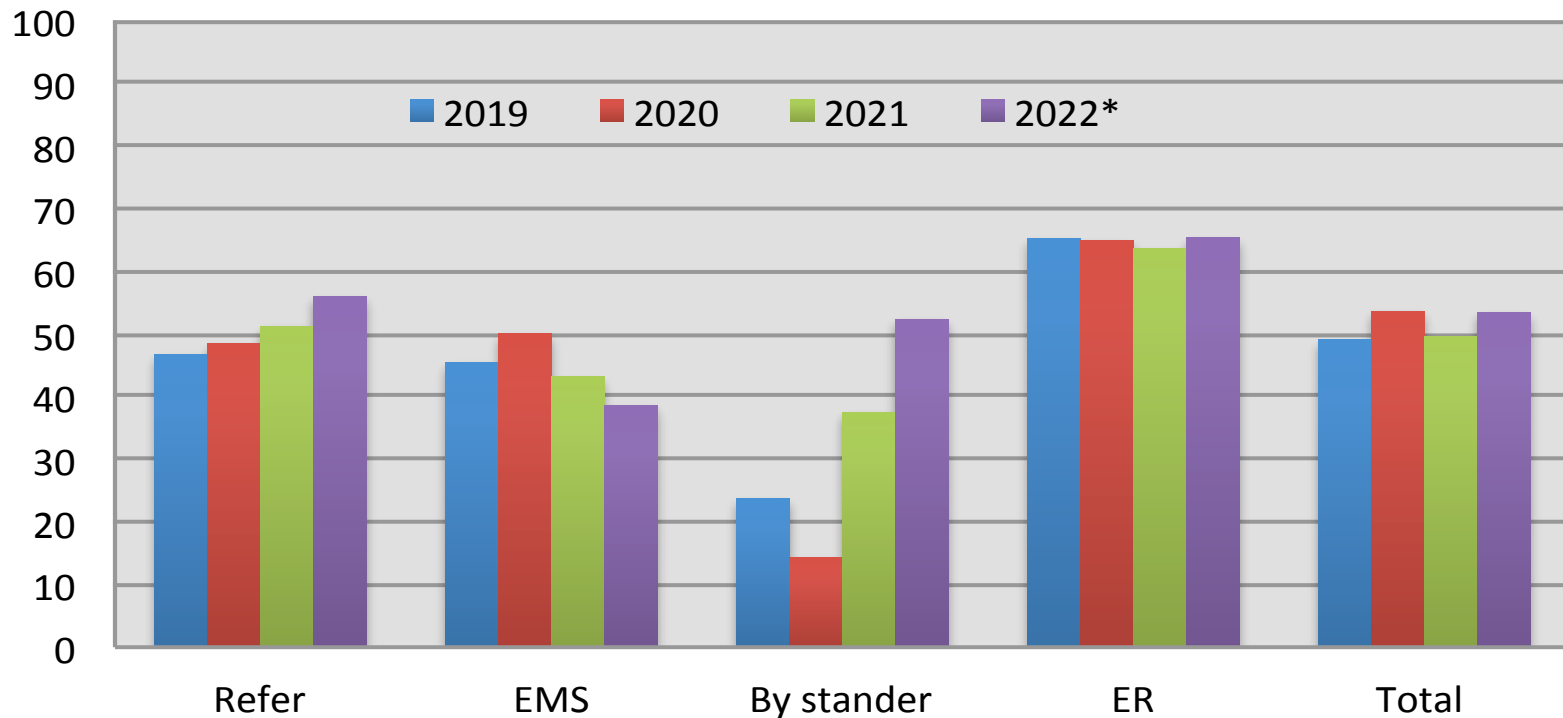

* 7 month



Percentage of ROSC , 2021

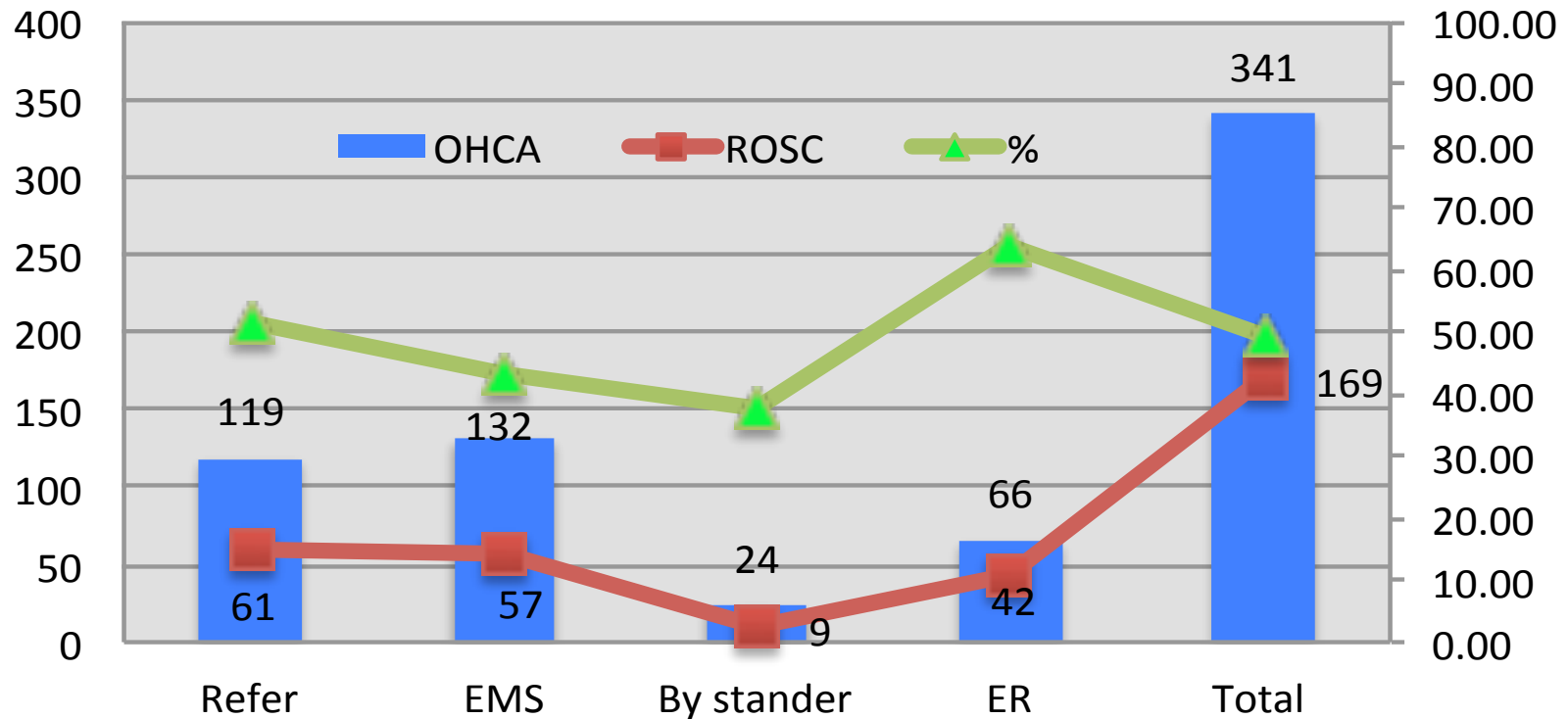

International Online Training

“ Capacity Building on Trauma Administrative Management for
Trauma Medical Directors and Trauma Nurse Coordinators in Southeast Asia Region ”



WHO Collaborating Centre
for Injury Prevention
and Safety Promotion



โรงพยาบาลขอนแก่น
KHON KAEN HOSPITAL



KKH

Khon Kaen CPR Challenge in
high school level



Training for students
and people in Khon
Kaen province

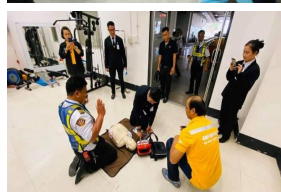

Training for monk



By stander CPR the monk



EMT CPR the monk



KhonKaen province
population 1,805,910

Year	Taget	TRAINING	%
2017	18,059	19,070	105.59
2018	18,059	19,229	106.47
2019	18,059	12,250	67.83
2021	18,059	6,366	35.25
2022	18,059	1,229	6.81
	90,296	58,144	64.39

International Online Training
“ Capacity Building on Trauma Administrative Management for
Trauma Medical Directors and Trauma Nurse Coordinators in Southeast Asia Region ”



WHO Collaborating Centre
for Injury Prevention
and Safety Promotion



โรงพยาบาลขอนแก่น
KHON KAEN HOSPITAL



THANK YOU

